

B-B

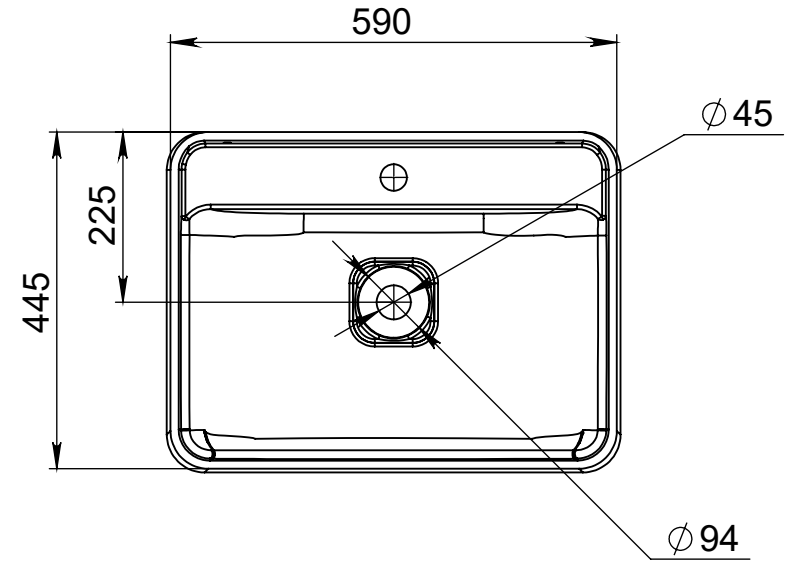

A-A

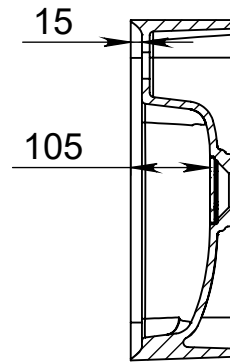
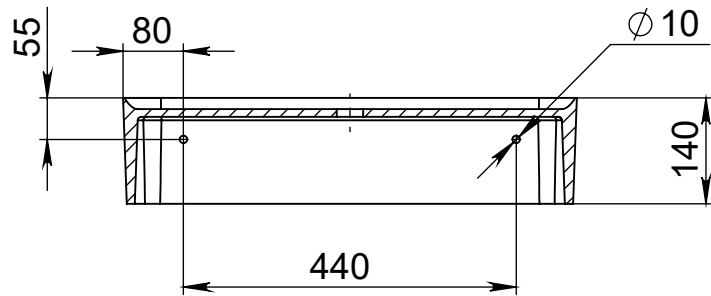

Length tolerance	+3/-3 mm	Design engineer	Date of project	Length tolerance (mm)	+3/-3 mm	Scale	1:10
Width tolerance	+1,5/-1,5mm	Project ID	01.61	Name	Marrakesh 600		
Tap hole positional tolerance	+3/-3 mm	Miraggio		Art. N°			
Overflow positional tolerance	+3/-3 mm			Dimensions	600/450		
Highth tolerance	+2/-2 mm	Weight tolerance	±3%	Weight			