

A-A

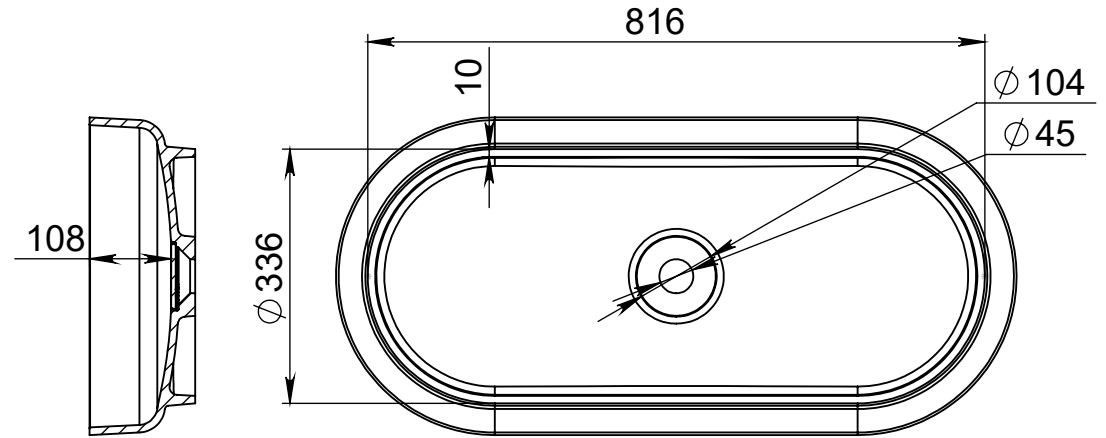

B-B

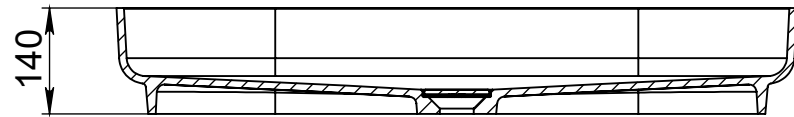

Length tolerance	+3/-3 mm	Design engineer	Date of project	Length tolerance (mm)	+3/-3 mm	Scale	1:10
Width tolerance	+1,5/-1,5mm	Project ID	01.65	Name	Marta 900		
Tap hole positional tolerance	+3/-3 mm	<b>Miraggio</b>		Art. N°	900/420		
Overflow positional tolerance	+3/-3 mm			Dimensions	900/420		
Highth tolerance	+2/-2 mm	Weight tolerance	±3%	Weight			